



Three years ago, with logo Gri, born two twins companies, whose mission is to develop and produce innovative accessories for inflatable field. The most important mission that we have set is the satisfaction of our customers: not only to supply high-quality innovative products, but also to offer a service rapid and precise.

Today the brand GRI, besides supplying directly to the major part of inflatable items factory in China, export also his products to more than 30 nations. The new 3600m² operative site locates in Sanqishi Town-Yuyao, which can be achieved in 30 minutes from Ningbo airport and in 2 hours from Shanghai airport.

两年前，伴随着GRI这个商标，诞生了两家姊妹公司。其使命是为充气行业开发及生产具有创新性的配件。其中最重要的使命是满足我们的客户：不仅仅是提供高质量，有创新性的产品，还要提供快速、精确的服务。

今天，品牌GRI，除了直接供给到中国大部分充气行业的厂家外，还出口到30多个国家和地区。新的3600平方米的厂房坐落在余姚三七市镇，离宁波机场有30分钟车程，离上海机场为2小时车程。

Ningbo Jing Quan Import&Export Co.,Ltd.
宁波景铨进出口有限公司

Yuyao Ermanno Plastic Technology Co.,Ltd.
余姚爱玛诺塑料科技有限公司

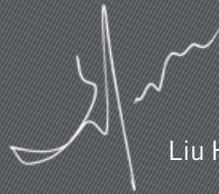

Liu Huan (Nolan)





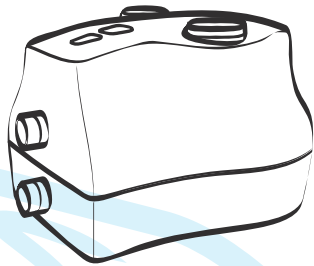
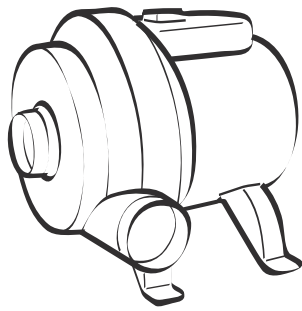
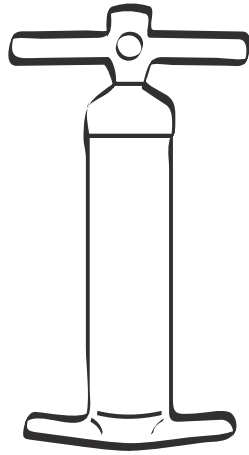

INDEX

HP1	hand pump for KITE surf DOUBLE ACTION	6
HP3	hand pump for BIG KITE surf DOUBLE ACTION	7
HP2	hand pump for ISUP board DOUBLE ACTION	8
HP1-2-3	SPECIAL VERSION	9
HP1-2-3	SPECIAL ACTION SWITCH	10
Adapters	and special accessories for pumps	11
HP4	hand pump for BIG KITE surf TRIPLE ACTION	12
HP5	hand pump for BIG ISUP board TRIPLE ACTION	13
AC1 & AC2	professional electrical inflator for tents	14
AC3	professional electrical inflator for tents	15
AC1-2-3	accessory IP54	15
EP1	electric pump for BIG ISUP board - TURBO BOOSTER	16
EP2	electric pump for ISUP board	17
EP3	electric pump for BIG kite surf - TURBO BOOSTER	18
EP4	electric pump for kite surf	19

INDEX

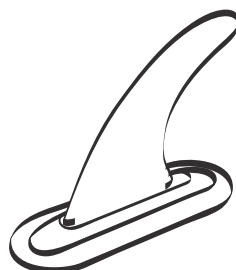
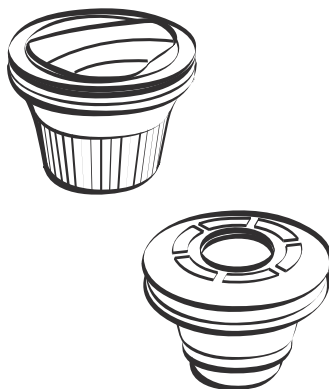
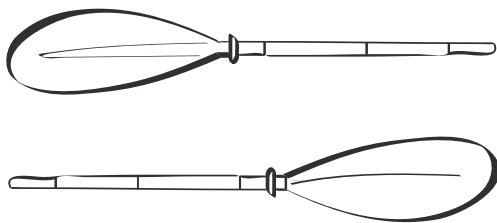
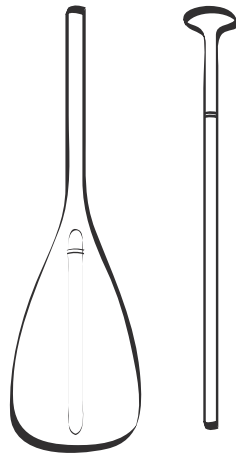

PS1	ALU telescopic ISUP paddle	20
PS3	ALU telescopic ISUP paddle KIDS	20
PS2	ALU telescopic ISUP/KAYAK paddle - COMBO	21
PSG	FIBER telescopic ISUP paddle	21
PS5	ALU telescopic ISUP paddle	22
PS6	ALU telescopic ISUP paddle KIDS	22
PS7	ALU telescopic ISUP/KAYAK paddle - COMBO	23
PSH	FIBER telescopic ISUP paddle	23
PK1	ALU kayak paddle	24
PK2	ALU kayak paddle	24
PKG	FIBER kayak paddle	25
PK1-2-G	SPECIAL VERSION	25
V1	boat valve	26
V4	boat valve	26
V3	ISUP valve	27
V5	ISUP valve	27
V2	KITE surf valve	28
KEY1	key for valve	28
KEY2	key for valve	28
GM1	gauge meter adapter	29
RV1	relief valve	29
FN1 & FN4	removable fin	30
FN2 & FN3	PVC fin	30

HP1

hand pump for KITE surf
DOUBLE ACTION

PATENTED

Inflating the kite makes kitesurfers suffer before having fun. For this reason we decided to realize a hand pump more comfortable, rapid and robust. HP1 being used in double action and then single action, can achieve 13 psi rapidly and effortlessly. It's completely customizable for color, graphic and calibration of gauge meter.

在开始愉快的风筝之旅之前，给风筝充气总是让风筝玩家感到痛苦。为此，我们决定实现一款舒适，快速并且强大的手打气泵。HP1可以先双向使用，然后单向，这样可以轻松快速地达到13psi。颜色，压力表的图像及量程完全可以按照要求定制。

Features:

- capacity 2.3+2.3L, max. pressure 13psi as DIN EN 16051
- seals and anti-sand filter for long life of pump and kite
- longer body and high-airflow piston for an easier inflation
- switch tap for double/single action
- shockproof gauge meter

For special version please see page 9 and 10.

For adapters available, please see page 11.

特性:

- 2.3+2.3L的气流量，根据标准DIN EN 16051测试最高压力为13psi
- 垫圈及防沙滤网均保证气泵和风筝的寿命更长
- 更高的气泵及大流量的活塞保证了一个更轻松的充气过程
- 旋塞转换气泵的双/单向工作
- 防爆压力表

特殊版本请见第9及第10页。

可配接头请见第11页。



HP3 hand pump for BIG KITE surf

DOUBLE ACTION

PATENTED

This pump is designed specifically for big kite surf and kite schools. The huge capacity of inflation and the extra tall body allow an comfortable inflation of big kites. HP3 being used in double action and then single action, can achieve 13 psi rapidly and effortlessly. It's completely customizable for color, graphic and calibration of gauge meter.

这款手打气泵专门为大型风筝及风筝学校而设计。巨大的气流量及更高的筒身保证了一个更舒适的充大型风筝的充气过程。HP3可以先双向使用，然后单向，这样可以轻松快速地达到13psi。颜色，压力表的图像及量程完全可以按照要求定制。

Features:

- capacity 2.9+2.9L, max. pressure 13psi as DIN EN 16051
- seals and anti-sand filter for long life of pump and kite
- extra long body and high-airflow piston for an easier inflation
- switch tap for double/single action
- shockproof gauge meter

For special version please see page 9 and 10.

For adapters available, please see page 11.

特性:

- 2.9+2.9L的气流量，根据标准DIN EN 16051测试最高压力为13psi
- 垫圈及防沙滤网均保证气泵和风筝的寿命更长
- 特别高的气泵及大流量的活塞保证了一个更轻松的充气过程
- 旋塞转换气泵的双/单向工作
- 防爆压力表

特殊版本请见第9及第10页。

可配接头请见第11页。



HP2

hand pump for ISUP board
DOUBLE ACTION

PATENTED

The modern ISUP board must be inflated to very high pressure to get optimum performance. For this reason we decided to realize a hand pump more comfortable, rapid and robust. HP2 being used in double action and then single action, can achieve 26 psi rapidly and effortlessly. It's completely customizable for color, graphic and calibration of gauge meter.

现代的SUP板都需要充到一个非常高的压力以获得最佳性能。为此，我们决定实现一款舒适，快速并且强大的手打气泵。HP2可以先双向使用，然后单向，这样可以轻松快速地达到26psi。颜色，压力表的图像及量程完全可以按照要求定制。

Features:

- capacity 1.8+1.8L, max. pressure 26psi as DIN EN 16051
- seals and anti-sand filter for long life of pump and ISUP board
- high-airflow piston for an easier inflation
- switch tap for double/single action
- shockproof gauge meter

For special version please see page 9 and 10.

For adapters available, please see page 11.

特性:

- 1.8+1.8L的气流量，根据标准DIN EN 16051测试最高压力为26psi
- 垫圈及防沙滤网均保证气泵和SUP板的寿命更长
- 大流量的活塞保证了一个更轻松的充气过程
- 旋塞转换气泵的双/单向工作
- 防爆压力表

特殊版本请见第9及第10页。

可配接头请见第11页。



HP1-2-3 SPECIAL VERSION



HP1



HP2



HP3

		STANDARD version	SPECIAL version
 <p>Handle with screw connect 螺纹式连接手把</p>		HP1	HP1-S
		HP2	
		HP3	HP3-S
 <p>Handle with function INFLATE-DEFLATE. Bayonet connect. 带有充放气功能手把。卡口式连接</p>		HP1	HP1-D
		HP2	
		HP3	HP3-D
 <p>Handle with function INFLATE-DEFLATE. Screw connect. 带有充放气功能手把。螺纹式连接</p>		HP1	HP1-SD
		HP2	HP2-D
		HP3	HP3-SD
 <p>Handle for basic pump HP2-B, without sand filter. 基础款气泵HP2-B手把，不带滤网。</p>		HP2-B	

HP1-2-3

SPECIAL ACTION SWITCH

NEW

PATENTED



HP1-R



HP2-R



HP3-R

New patented top cap with switch single-double action. Intuitive, rapid and robust use. With filter integrated.

新的专利过的单双向转换旋钮上盖。清晰，快速使用并且牢固。滤网内嵌。

A HIGH CAPACITY

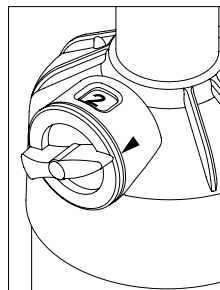

B HIGH PRESSURE

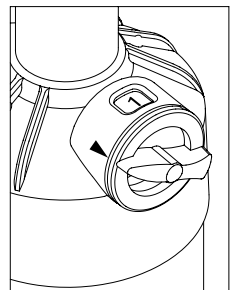

Adapters available for KITE surf



55106



55133



55107



55104 BLACK



55104 RED



for BOSTON valve

for PVC valve

for HR, Korea V4&V5 valve

for V1, V2 & V3 valve

55108



55129



55130



55134



for special valve

Adapters available for ISUP

55115 BLACK



55115 RED



55132



for HR, Korea, V4&V5 valve

for V1, V2&V3 valve

for C7&D7 valve

Special accessories for pumps



In this zone the leash is inserted itself and sewed

Special leash and hook for KITE
风筝用特殊绳子及钩子



Mesh bag or nylon bag customizable
可定制网袋或尼龙袋

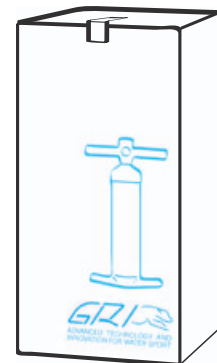

HP1: 280x120x515 mm
HP2: 280x110x625 mm
HP3: 280x120x625 mm

Color box customizable
可定制彩盒

HP4 hand pump for BIG KITE surf

TRIPLE ACTION

TRIPLE ACTION **PATENTED**

To complete our hand pump range for KITE surf, we invented the first pump TRIPLE action! HP4 combines an huge capacity of inflation and an extreme ease to achieve high pressures, it's designed to inflate BIG KITE surf or boat, tents etc.

HP4, being used in TRIPLE-double-single action, can achieve 13psi rapidly and effortlessly. The switching 3-2-1 can be realized easily and comfortably rotating the switch knob. It's completely customizable for color, graphic and calibration of gauge meter.

为了使我们充风筝的手拉气泵产品线更完整，我们开发了首款三相气泵！HP4，既有巨大的气流量，还能轻松地达到高压，主要为大型风筝或船，帐篷等设计。

HP4可以三向-双向-单向使用，轻松快速地达到13psi。开关3-2-1的调节可以轻松简便地通过转动开关来实现。颜色，压力表的图像及量程完全可以按照要求定制。

Features:

- capacity 5.5+5.5L, max. pressure 13psi as DIN EN 16051
- switch to change comfortably from triple to double or single
- seals and anti-sand filter for long life of pump and kite
- extra long body and high-airflow piston for an easier inflation
- shockproof gauge meter

For adapters available, please see page 11.

特性:

- 5.5+5.5L的气流量，根据标准DIN EN 16051测试最高压力为13psi
- 舒适切换三向-双向-单向的开关
- 垫圈及防沙滤网均保证气泵和风筝的使用寿命更长
- 特别高的气泵及大流量的活塞保证了一个更轻松的充气过程
- 防爆压力表

可配接头请见第11页。

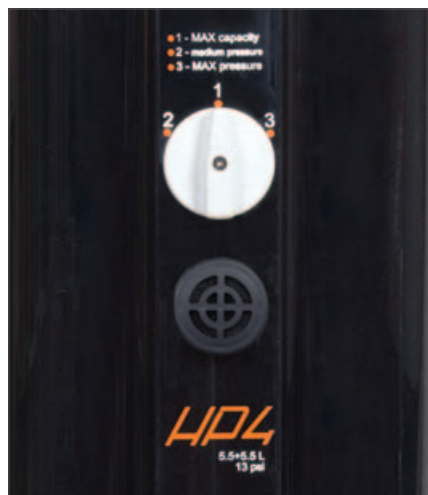

HP5 hand pump for BIG ISUP board

TRIPLE ACTION

TRIPLE ACTION **PATENTED**

To complete our hand pump range for ISUP, we invented the first pump TRIPLE action! HP5 combines an huge capacity of inflation and an extreme ease to achieve high pressures, it's designed to inflate BIG ISUP and popular multi persons ISUP. HP5, being used in TRIPLE-double-single action, can achieve 26psi rapidly and effortlessly. The switching 3-2-1 can be realized easily and comfortably rotating the switch knob. It's completely customizable for color, graphic and calibration of gauge meter.

为了使我们充ISUP的手拉气泵产品线更完整，我们开发了首款三相气泵！HP5，既有巨大的气流量，还能轻松地达到高压，主要为大型ISUP及流行的多人ISUP设计。HP5可以三向-双向-单向使用，轻松快速地达到26psi。开关3-2-1的调节可以轻松简便地通过转动开关来实现。颜色，压力表的图像及量程完全可以按照要求定制。

Features:

- capacity 3,5+3,5L, max. pressure 26 psi as DIN EN 16051
- switch to change comfortably from triple to double or single
- seals and anti-sand filter for long life of pump and ISUP
- extra long body and high-airflow piston for an easier inflation
- shockproof gauge meter

For adapters available, please see page 11.

特性:

- 3.5+3.5L的气流量，根据标准DIN EN 16051测试最高压力为26psi
- 舒适切换三向-双向-单向的开关
- 垫圈及防沙滤网均保证气泵和SUP板的寿命更长
- 特别高的气泵及大流量的活塞保证了一个更轻松的充气过程
- 防爆压力表

可配接头请见第11页。



AC1 & AC2

professional electrical inflator for tents

NEW

PATENTED

Electrical inflator projected for inflating/deflating rapidly big inflatable structures without having problem of overheating. Available 230V/AC-50Hz or 120V/AC-60Hz.

专门为大型充气产品设计的充放气专业电动泵，不会有过热问题。有230V/AC-50Hz或120V/AC-60Hz。

Features:

- AC1 : power 1600W , 3300l/min , max pressure 4.8 psi
- AC2 : power 1200W , 3000l/min , max pressure 4.1 psi
- motor with forced cooling to avoid overheating
- made in material shockproof
- hose of 25 or 40mm. With transportation strap.

特性:

- AC1: 功率1600W, 流量3300L/m, 最大压力4.8psi
- AC2: 功率1200W, 流量3000L/m, 最大压力4.1psi
- 电机带强制冷却功能以避免过热问题
- 用防爆材料制作
- 气管有25mm或者40mm。带肩带



AC3

AUTOMATIC professional electrical inflator for tents

NEW

PATENTED

The same power and airflow of AC2, but with the automatical function in order to keep the pressure of your tents always constant. Pressure adjustable from 2.8 to 4.3 psi.

功率及流量和AC2相同，但是带有自动功能，使得您的帐篷可以经常保持在一个稳定的压力。压力可在2.8到4.3psi之间调节。

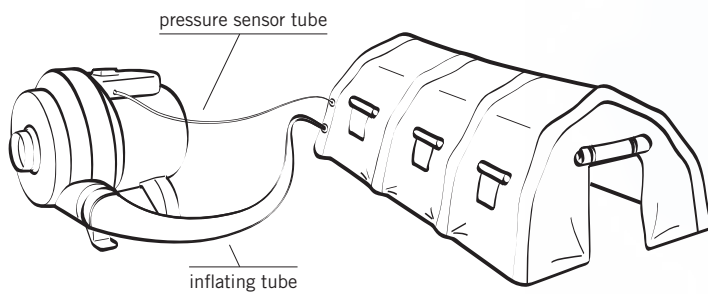

AC1-2-3

accessory IP54

An accessory that turns the electrical inflators AC1, AC2, AC3 into IP54. In this way the pump can work outside under rain.

这个配件使得电动泵AC1，AC2及AC3都可以转换成IP54。这样他们在雨中也可以工作。

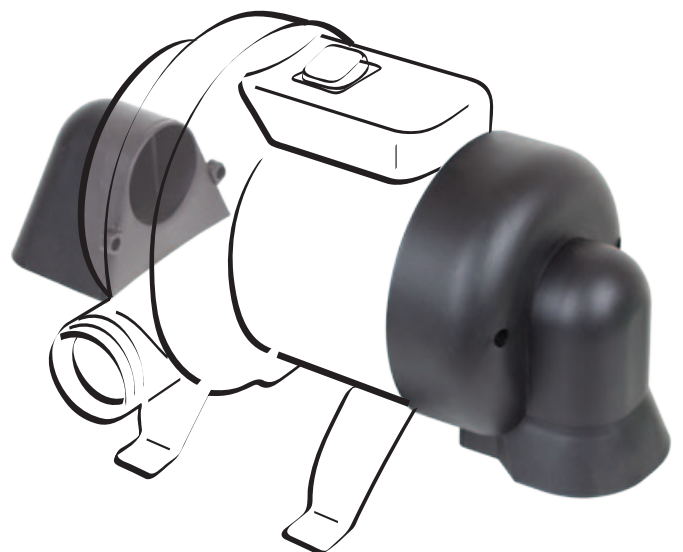

EP1

electric pump for BIG ISUP
board - TURBO BOOSTER

PATENTED

NEW

To complete our pump range for BIG ISUP, we developed an electrical pump of 12V, which conjugates a trend and functional aesthetic and a high efficiency performance. It's equipped a high-speed turbo and a twin-cylinder compressor which guarantee a rapid inflation. The high-efficiency piston and the patented cooling system allow to reach high pressures easily and safely. The special bag-filter and all HI-TECH components/material guarantee the long life the inflator.

为了完整我们充大型SUP板的气泵产品线，我们开发了一款12V的电动泵。这款气泵结合了潮流并功能性的外观及极高的性能及效率于一体。它由一个高速涡轮和一个双缸压缩机组成，他们保证了一个快速的充气过程。高效的活塞和专利的冷却系统使得达到高压是如此安全轻松。特殊的袋式滤网及所有高科技的部件/材质都保证气泵的长寿命。

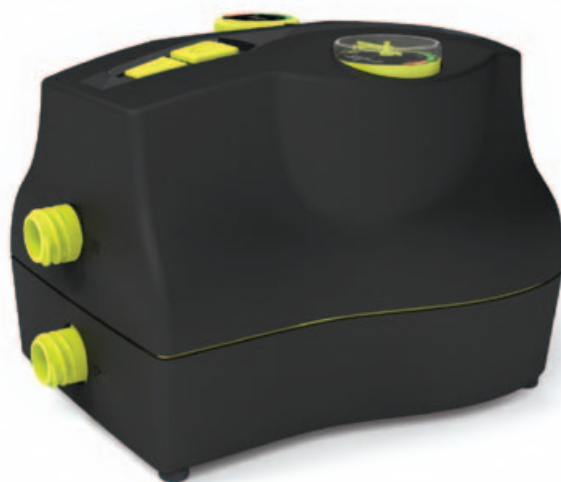

Features:

26psi

- max. airflow 450 L/min
- pressure adjustable from 11 to 26 psi, shutdown automatically
- with gauge meter to read contemporary the achieved pressure
- 12 V-DC; max 25A
- the rechargeable battery is available to install into the compartment of the bag

特性:

- 最大流量450L/m
- 压力可在11-26 psi之间调节，自动关闭
- 带压力表，可以同步读取达到的压力
- 12 V-DC ; 最大25A
- 可配备可充电电池，放置于包内的隔层



EP2 electric pump for ISUP board

NEW

PATENTED

To complete our pump range for ISUP, we developed an electrical pump of 12V, which conjugates a trend and functional aesthetic and a high efficiency performance. It's equipped a twin-cylinder compressor which guarantees a rapid inflation. The high-efficiency piston and the patented cooling system allow to reach high pressures easily and safely. The special bag-filter and all HI-TECH components/material guarantee the long life the inflator.

为了完整我们充SUP板的气泵产品线，我们开发了一款12V的电动泵。这款气泵结合了潮流并功能性的外观及极高的性能及效率于一体。它带有一个双缸压缩机，保证了一个快速的充气过程。高效的活塞和专利的冷却系统使得达到高压是如此安全轻松。特殊的袋式滤网及所有高科技的部件/材质都保证气泵的长寿命。



Features:

26psi

- max. airflow 180 L/min
- pressure adjustable from 11 to 26 psi, shutdown automatically
- with gauge meter to read contemporary the achieved pressure
- 12 V-DC; max 25A
- the rechargeable battery is available to install into the compartment of the bag

特性:

- 最大流量180L/m
- 压力可在11-26 psi之间调节，自动关闭
- 带压力表，可以同步读取达到的压力
- 12 V-DC ; 最大25A
- 可配备可充电电池，放置于包内的隔层



EP3

electric pump for BIG kite surf - TURBO BOOSTER

PATENTED

NEW

To complete our pump range for BIG KITE surf, we developed an electrical pump of 12V, which conjugates a trend and functional aesthetic and a high efficiency performance. It's equipped a high-speed turbo and a twin-cylinder compressor which guarantee a rapid inflation. The high-efficiency piston and the patented cooling system allow to reach high pressures easily and safely. The special bag-filter and all HI-TECH components/material guarantee the long life the inflator.

为了完整我们充大型风筝的气泵产品线，我们开发了一款12V的电动泵。这款气泵结合了潮流并功能性的外观及极高的性能及效率于一体。它由一个高速涡轮和一个双缸压缩机组成，他们保证了一个快速的充气过程。高效的活塞和专利的冷却系统使得达到高压是如此安全轻松。特殊的袋式滤网及所有高科技的部件/材质都保证气泵的长寿命。

Features:

- max.volume 450 L/min
- pressure adjustable from 2 to 14 psi, shutdown automatically
- with gauge meter to read contemporary the achieved pressure
- 12 V-DC; max 21A
- the rechargeable battery is available to install into the compartment of the bag

特性:

- 最大流量450L/m
- 压力可在2-14 psi之间调节，自动关闭
- 带压力表，可以同步读取达到的压力
- 12 V-DC ; 最大21A
- 可配备可充电电池，放置于包内的隔层



EP4

electric pump for kite surf

PATENTED

NEW

To complete our pump range for KITE surf, we developed an electrical pump of 12V, which conjugates a trend and functional aesthetic and a high efficiency performance. It's equipped a twin-cylinder compressor which guarantees a rapid inflation. The high-efficiency piston and the patented cooling system allow to reach high pressures easily and safely. The special bag-filter and all HI-TECH components/material guarantee the long life the inflator.

为了完整我们充风筝的气泵产品线，我们开发了一款12V的电动泵。这款气泵结合了潮流并功能性的外观及极高的性能及效率于一体。它带有一个双缸压缩机，保证了一个快速的充气过程。高效的活塞和专利的冷却系统使得达到高压是如此安全轻松。特殊的袋式滤网及所有高科技的部件/材质都保证气泵的长寿命。



Features:

- max.volume 180 L/min
- pressure adjustable from 2 to 14 psi, shutdown automatically
- with gauge meter to read contemporary the achieved pressure
- 12 V-DC; max 21A
- the rechargeable battery is available to install into the compartment of the bag

特性:

- 最大流量180L/m
- 压力可在2-14 psi之间调节，自动关闭
- 带压力表，可以同步读取达到的压力
- 12 V-DC ; 最大21A
- 可配备可充电电池，放置于包内的隔层



PS1

ALU telescopic ISUP paddle

Telescopic paddle in aluminum shaft with blade injected with gas assist injection which permits to have a rigidity and a low weight. The shaft is in aluminum and anodized in natural color, it's possible to make the shaft in black anodizing. Blade in reinforced polypropylene. It's possible to have blade color personalized.

铝桨杆伸缩桨，使用气辅成型科技注塑而成的桨叶既保证了坚硬度也保证了一个较轻的重量。桨杆是自然色氧化铝管，可以按照要求做成黑色氧化。桨叶由增强聚丙烯制成。可以按照要求定制桨叶颜色。

Features:

- adjustable length from 153 to 218cm
- light and FLOATING, 1130g
- shaft of 31 and 28mm in alloy 6005-T6
- compact: removable in 3 parts of 79cm

特性:

- 长度可在153到218cm之间调节
- 重量轻且上浮，1130g
- 桨杆由31及28mm的6005-T6铝杆组成
- 紧凑：可拆卸成3截，总长79cm



PS3

ALU telescopic ISUP paddle KIDS

Telescopic paddle in aluminum shaft for kids, with the same technical features of PS1

儿童用铝桨杆伸缩桨，技术特点同PS1

Features:

- adjustable length from 133 to 185cm
- light and FLOATING, 1030g
- shaft of 31 and 28mm in alloy 6005-T6
- compact: removable in 3 parts of 68cm

特性:

- 长度可在133到185cm之间调节
- 重量轻且上浮，1030g
- 桨杆由31及28mm的6005-T6铝杆组成
- 紧凑：可拆卸成3截，总长68cm



PS2

ALU telescopic ISUP/KAYAK paddle - COMBO

Same features as paddle PS1, but with an addition blade in order to transform it to KAYAK paddle. The length transforming into KAYAK is 198cm and the blade can be rotated 360°.

特性同PS1桨，但是多一个桨叶，以便于转换成皮划艇桨。转换成皮划艇桨后的长度是198cm，桨叶可以360°旋转。



PSG

FIBER telescopic ISUP paddle

Telescopic paddle in FIBERGLASS shaft with blade injected with gas assist injection which permits to have a rigidity and a low weight. Blade in reinforced polypropylene. It's possible to have blade color personalized.

玻纤杆伸缩桨，使用气辅成型科技注塑而成的桨叶既保证了坚硬度也保证了一个较轻的重量。桨叶由增强聚丙烯制成。可以按照要求定制桨叶颜色。

Features:

- adjustable length from 164 to 218cm
- light and FLOATING, 1020g
- shaft of 31 and 28mm in fiberglass with reinforced ring
- compact: removable in 3 parts of 79cm

特性:

- 长度可在164到218cm之间调节
- 重量轻且上浮，1020g
- 桨杆由31及28mm的玻纤杆组成，有横向加强圈
- 紧凑：可拆卸成3截，总长79cm



PS5

ALU telescopic ISUP paddle

NEW

Telescopic paddle in aluminum shaft with NEW blade injected with the gas assist injection which permits to keep a good rigidity and a low weight. The shaft is in aluminum and anodized in natural color, it's possible to make the shaft in black anodizing. Blade in reinforced polypropylene and rapid hook in reinforced nylon. It's possible to have blade color personalized.

铝桨杆伸缩桨，使用气辅成型科技注塑而成的桨叶既保证了坚硬度也保证了一个较轻的重量。桨杆是自然色氧化铝管，可以按照要求做成黑色氧化。桨叶由增强聚丙烯制成，快速卡扣由增强尼龙制成。可以按照要求定制桨叶颜色。

Features:

- adjustable length from 153 to 218cm
- light and FLOATING, 950g
- shaft of 29 and 26.5mm in alloy 6005-T6
- compact: removable in 3 parts of 79cm

特性:

- 长度可在153-218cm之间调节
- 重量轻且上浮，950g
- 桨杆由29及26.5mm的6005-T6铝杆组成
- 紧凑：可拆卸成3截，总长79cm



PS6

ALU telescopic ISUP paddle
KIDS

NEW

Telescopic paddle in aluminum shaft for kids, with the same technical features of PS5

儿童用铝桨杆伸缩桨，技术特点同PS5

Features:

- adjustable length from 133 to 185cm
- light and FLOATING, 900g
- shaft of 29 and 26.5mm in alloy 6005-T6
- compact: removable in 3 parts of 68cm

特性:

- 长度可在133-185cm之间调节
- 重量轻且上浮，900g
- 桨杆由29及26.5mm的6005-T6铝杆组成
- 紧凑：可拆卸成3截，总长68cm



PS7

ALU telescopic ISUP/KAYAK paddle - COMBO

NEW

Same features as paddle PS5, but with an addition blade in order to transform it to KAYAK paddle. The length transforming into KAYAK is 198cm and the blade can be rotated 360°.

特性同PS5，但是多一个桨叶，以便于转换成皮划艇桨。转换成皮划艇桨后的长度是198cm，桨叶可以360°旋转。



PSH

FIBER telescopic ISUP paddle

NEW

Telescopic paddle in FIBERGLASS shaft with NEW blade injected with the gas assist injection which permits to keep a good rigidity and a low weight. Blade in reinforced polypropylene and rapid hook in reinforced nylon. It's possible to have blade color personalized.

玻纤桨杆伸缩桨，使用气辅成型科技注塑而成的桨叶既保证了坚硬度也保证了一个较轻的重量。桨叶由增强聚丙烯制成，快速卡扣由增强尼龙制成。可以按照要求定制桨叶颜色。

Features:

- adjustable length from 164 to 218cm
- light and FLOATING, 900g
- shaft of 29 and 26.5mm in fiberglass with reinforced ring
- Compact: removable in 3 parts of 79cm

特性:

- 长度可在164-218cm之间调节
- 重量轻且上浮，900g
- 桨杆由29及26.5mm的6005-T6铝杆组成
- 紧凑：可拆卸成3截，总长79cm



PK1

ALU kayak paddle

NEW

Kayak paddle in aluminum shaft with blade injected with gas assist injection which permits to keep a good rigidity and a low weight. The shaft is in aluminum and anodized in natural color, it's possible to make the shaft in black anodizing. Blade in reinforced polypropylene and rapid hook in reinforced nylon. It's possible to have blade color personalized.

铝杆皮划艇桨，使用气辅成型科技注塑而成的桨叶既保证了坚硬度也保证了一个较轻的重量。桨杆是自然色氧化铝管，可以按照要求做成黑色氧化。桨叶由增强聚丙烯制成，快速卡扣由增强尼龙制成。可以按照要求定制桨叶颜色。

Features:

- dimension on require from 210 a 240cm (900-1200g)
- shaft of 29mm in alloy 6005-T6
- compact: removable in 2 parts

特性:

- 长度可在210-240cm（900-1200g）范围内按要求定制
- 29mm的桨杆，材质为 6005-T6铝杆
- 紧凑：可拆卸成2截

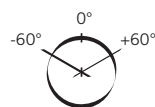

PK2

ALU kayak paddle

NEW

Same features as paddle PK1, but the blade can be dissembled and paddle becomes 4 parts.

特性同PK1，但是桨叶可拆卸，以便于将整支桨变成4截。

Features:

- dimension on require from 210 a 240cm (900-1200g)
- shaft of 29mm in alloy 6005-T6
- compact: removable in 4 parts

特性:

- 长度可在210-240cm（900-1200g）范围内按要求定制
- 29mm的桨杆，材质为 6005-T6铝杆
- 紧凑：可拆卸成4截

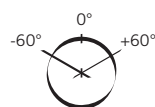

PKG

FIBER kayak paddle

NEW

Kayak paddle in fiberglass shaft with blade injected with gas assist injection which permits to keep a good rigidity and a low weight. Blade in reinforced polypropylene and rapid hook in reinforced nylon. It's possible to have blade color personalized.

玻纤杆皮划艇桨，使用气辅成型科技注塑而成的桨叶既保证了坚硬度也保证了一个较轻的重量。桨叶由增强聚丙烯制成，快速卡扣由增强尼龙制成。可以按照要求定制桨叶颜色。

Features:

- dimension on require from 210 a 240cm (850-1150g)
- shaft of 29mm in fiberglass
- 3 hole push button ferrule (60 degree L, Zero, 60 degree R)
- compact: removable in 2 parts

特性:

- 长度可在210-240cm (850-1150g) 范围内按要求定制
- 29mm的桨杆，材质为 6005-T6铝杆
- 有3个按钮孔（左60°，0°，右60°）
- 紧凑：可拆卸成4截

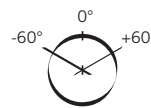

PK1-2-G

telescopic version

NEW

With this special joint in reinforced nylon, it's possible to orientate the blade of 360° and longer the paddle length of 15cm. Available for PK1, PK2 and PKG.

这个特殊增强尼龙制成的连接件，可以使桨叶旋转360°并且使桨叶长度增加15cm。可以用于PK1, PK2及PKG。



V1 boat valve

(code black : V1001 / code grey : V1002)

PATENTED

This valve is designed to be used in all inflatable fields, where the tubulars are mono-coated or bi-coated. It's the best for boat, kayak and inflatable PVC tent.

这个气阀可用于所有的充气行业，不管气囊是单层面料还是双层的。最适用于船，SUP板和PVC充气帐篷。

Features:

- open-close in push-push system
- all the material and components are UV resistance, the gasket is in high quality silicon
- ferrule with built-in filter for elevate air flow
- test 100%
- dimension: \varnothing 60xH42mm. \varnothing thread 38mm.

特性:

- 开启-关闭采用圆珠笔式按压
- 所有的材料和零件都抗紫外，垫圈是高质量的硅胶
- 下盖内嵌滤网，可保证高气流量
- 100%全检
- 尺寸：直径60x高度42mm。螺纹直径38mm。

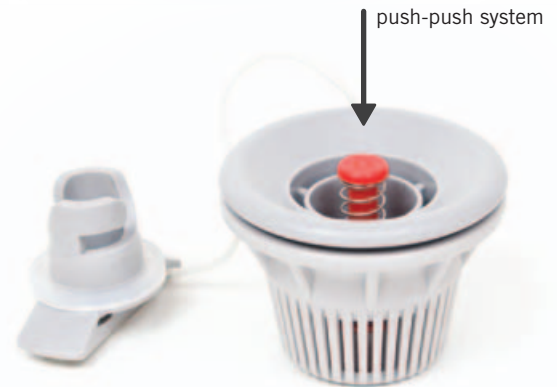

V4 boat valve

(code black : V4001 / code grey : V4002)

PATENTED

Same features as valve V1, but use the classical open-close system PUSH-TURN.

特性同V1，但是采用经典的按下-旋转的开启关闭方式。

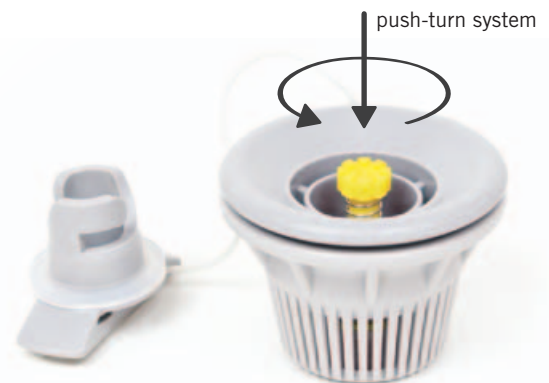

V3 ISUP valve

(code black : V3001 / code grey : V3002)

PATENTED

This valve is designed to be used with drop stitch material, in fact its thin and robust filter on the ferrule blocks the stitches inside board entering the valve. It's the best for kayak and ISUP board.

这个阀门是为使用拉丝线为面料的产品而设计的，细小而牢固的滤网可以防止板子内部的拉丝进入到阀门内部。最适合用于皮划艇及SUP板。

Features:

- open-close in push-push system
- all the material and components are UV resistance, the gasket is in high quality silicon
- ferrule with mesh filter
- test 100%
- dimension: Ø 60xH42mm. Ø thread 38mm.

特性:

- 开启-关闭采用圆珠笔式按压
- 所有的材料和零件都抗紫外，垫圈是高质量的硅胶
- 下盖外包有滤网布
- 100%全检
- 尺寸：直径60x高度42mm。螺纹直径38mm。



V5 ISUP valve

(code black : V5001 / code grey : V5002)

PATENTED

Same features as valve V3, but use the classical open-close system PUSH-TURN.

特性同V3，但是采用经典的按下-旋转的开启关闭方式。



V2

KITE surf valve

(code black : V2001)

PATENTED

This valve is designed to be used in all inflatable fields, where the tubulars are made up of PU bladder and external sheath. Push-push opening, very elevate air flow, easy to be assembled.

这个气阀可用于所有气囊是由PU内层和外部套管组成的充气行业。圆珠笔式按压开启-关闭方式，高气流量，易安装。

Features:

- PVC base can be welded to PU bladder. The valve body retains the external sheath
- all the material and components are UV resistance, the gasket is in high quality silicon
- test 100%
- dimension valve \varnothing 45xH29mm. dimension PVC base \varnothing 72xH34mm

特性:

- PVC底座，可焊接到PU内层。阀门主体卡住外部套管
- 所有的材料和零件都抗紫外，垫圈是高质量的硅胶
- 100%全检
- 阀门主体尺寸：直径45x高度29mm。PVC底座尺寸：直径72x高度34mm



KEY1

key for valve

(code : Key01)

Tightening wrench reinforced in nylon for valves V1, V2, V3 and RV1

增强尼龙制成的阀门扳手，用于V1，V2，V3及RV1



KEY2

key for valve

(code : Key02)

Tightening wrench reinforced in nylon for valves V4, V5 and HR or similar.

增强尼龙制成的阀门扳手，用于V4，V5和HR及类似阀门



GM1

gauge meter adapter

PATENTED

Gauge meter Adapter for valve type HR or similar, completely customizable for calibration, graphic and color. Accurate, compact and economical. Calibration for boat, kayak, tent and ISUP as per require.

适用于HR或类似阀门的压力表接头，完全可以按照要求定制压力表的量程，图像及颜色。精确，紧凑并经济。有很多适用于船，皮划艇，帐篷，风筝及SUP板的量程可用。

Features:

- shockproof and floating
- it's possible to create adapters for other type of valves (Leaffield, Boston, etc.) as per require

特性:

- 防爆并上浮
- 可按要求做适用于其他阀门（如Leaffield, Boston等）的接头



RV1

relief valve

PATENTED

It's ideal for any application while there's high risk of contamination and necessary to have a relief valve very compact, accurate and robust. The very fine filter of 90 microns doesn't compromise the airflow of the valve.

对于很有可能被搞脏及有必要用到一款紧凑、精确及牢固的安全阀的应用来说，这是一款非常理想的安全阀。90微米的极细滤网不会影响到阀门放气的流量。

Features:

- calibration per boat, kayak, tent and ISUP as per require
- all the material and components are UV resistance, the gasket is in high quality silicon
- body with stainless steel filter , ferrule with mesh filter
- test 100% in opening and closing
- dimension: Ø 47xH32mm. Ø thread 24mm.

特性:

- 按照要求有适用于船，皮划艇，帐篷及SUP板的量程
- 所有的材料和零件都抗紫外，垫圈是高质量的硅胶
- 主体带不锈钢滤网，下盖外包有滤网布
- 开启及关闭点100%全检
- 尺寸：直径47x高度32mm。螺纹直径24mm。



FN1 & FN4

(code black : FN104 & FN401)

removable fin

PATENTED

Central and side fins made in reinforced nylon and shock-proof ABS. Compact and robust. Equipped with quick hook-release system which is patented. Color can be personalized based on require.

Dimension FN1 : 280x100x220mm

Dimension FN4 : 180x75x140mm

中央鳍片及边鳍由增强尼龙及防爆ABS制成。紧凑并牢固。配备快速释放制动系统，并已获得专利。颜色可以按照要求定制。

产品尺寸 FN1: 280x100x220mm

产品尺寸 FN4: 180x75x140mm



FN2 & FN3

(code black : FN201)

PVC fin

Side fin made in PVC. Color can be personalized based on require.

Dimension FN2: 195x55x110mm

Dimension FN3: 215x55x75mm

PVC边鳍。颜色可以按要求定制。

产品尺寸 FN2: 195x55x110mm

产品尺寸 FN3: 215x55x75mm



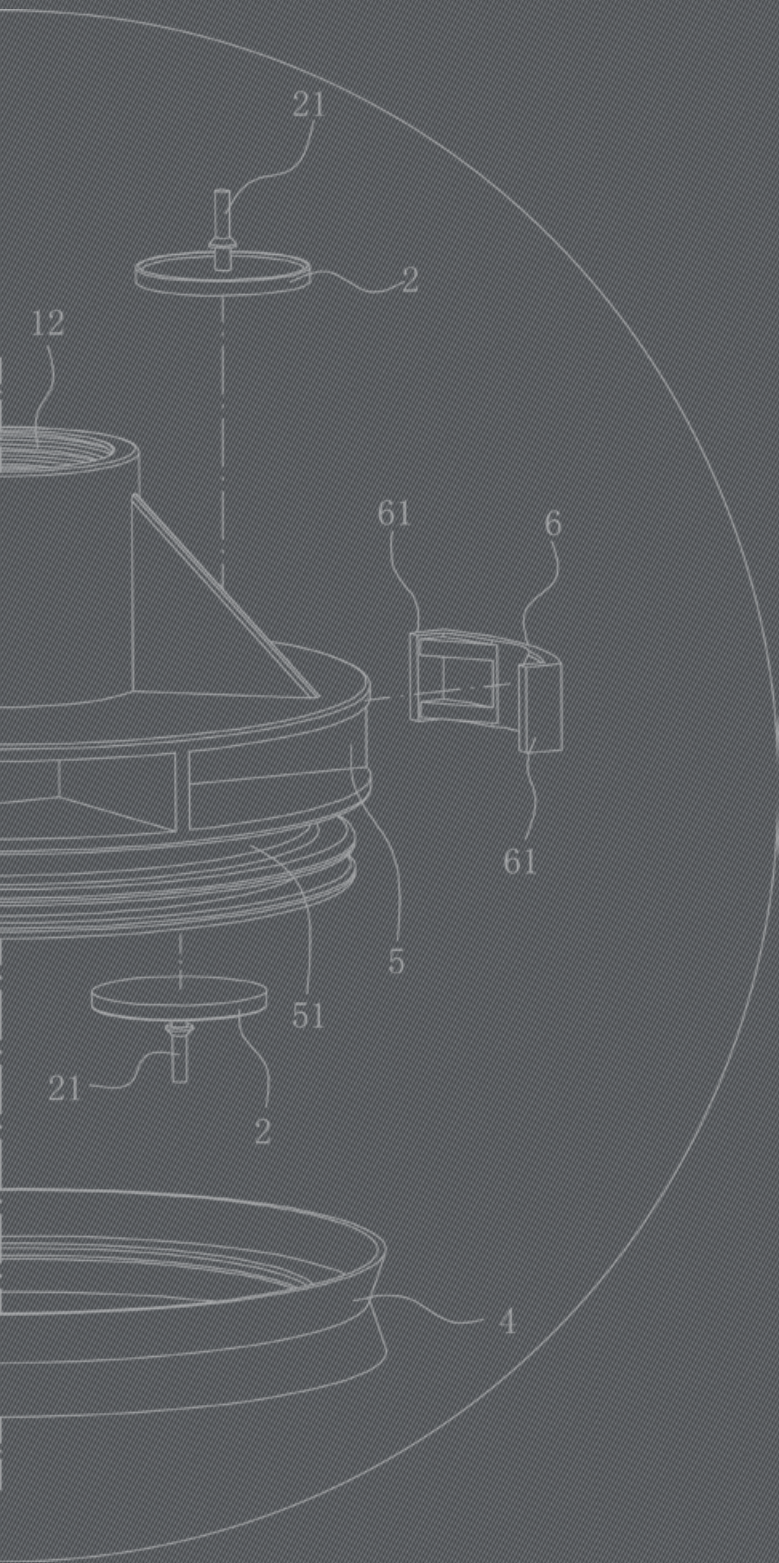

PATENTED by 

ZL 2014 1 0330801. 4	ZL 2014 2 0711166. x
ZL 2014 2 0384139. 6	ZL 2014 1 0748677. 3
ZL 2014 2 0387107. 1	ZL 2014 2 0769644. 2
ZL 2014 2 0387110. 3	ZL 2015 1 0476721. 4
ZL 2014 2 0403847. x	ZL 2015 2 0588358. 0
ZL 2014 3 0247075. 0	ZL 2015 3 0293383. 1
ZL 2014 3 0246918. 5	ZL 2015 3 0333843. 9
ZL 2014 3 0233648. 4	ZL 2015 2 0674874. 5
ZL 2014 3 0233620. 0	ZL 2015 2 0672621. 4
ZL 2014 1 0333280. 8	ZL 2015 3 0333713. 5
ZL 2014 1 0344095. 9	ZL 2015 2 0881815. 5
ZL 2014 2 0399324. 2	ZL 2015 3 0542084. 7
ZL 2014 2 0405490. 9	ZL 2015 3 0542073. 9
ZL 2014 1 0623357. 5	ZL 2016 2 0049710. 8
ZL 2014 2 0660484. 8	PCT/CN 2015 / 000482



ADVANCED TECHNOLOGY AND INNOVATION FOR WATER SPORT

Ningbo Jing Quan Import and Export Co.,Ltd.
宁波景铨进出口有限公司

Yuyao Ermanno Plastic Technology Co.,Ltd.
余姚爱玛诺塑料科技有限公司

Operative Add.: No.2, Jingtou Village, Sanqishi Town, Yuyao, Zhejiang, China, 315412
办公地址：浙江省余姚市三七市镇井头村2号 315412

Tel.: +86 574 62925093 / +86 574 62925756

Fax: +86 574 62925092 - Cell. : +86 13566312909

www.j-quan.com - sales@j-quan.com

